

27 789 970









Passt zu: ELIO, TARA, TARA ULTRA

- Brausestrahl
- automatischer Umschalter Auslauf/Profi-Garnitur
- Armaturenhöhe 665 mm
- Einzelrosette Ø 55 mm
- Bohrungsdurchmesser Profibrause 30 mm
- Sprayface mit Antikalk-System
- bleifrei

Nur kombinierbar mit 33826790, 32800790, 33826888, 32815888, 20815892, 33826875.

Eigensicher gegen Rückfließen.

	Chrom	27 789 970-00
	Platin gebürstet	27 789 970-06
	Platin	27 789 970-08
	Dark Chrome	27 789 970-19
	Chrom gebürstet (Edelstahl-Look)	27 789 970-93
	Dark Platinum gebürstet	27 789 970-99

27 789 970

mm [inches]
M 1:10

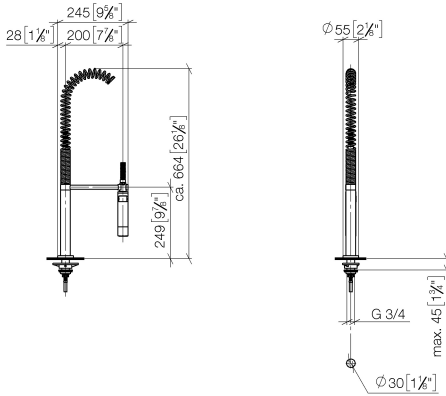

Durchflussdiagramm



Zertifikate

LGA_18901.

LGA_28304.

Belgaqua_22_277_2
7_3.

27 789 970

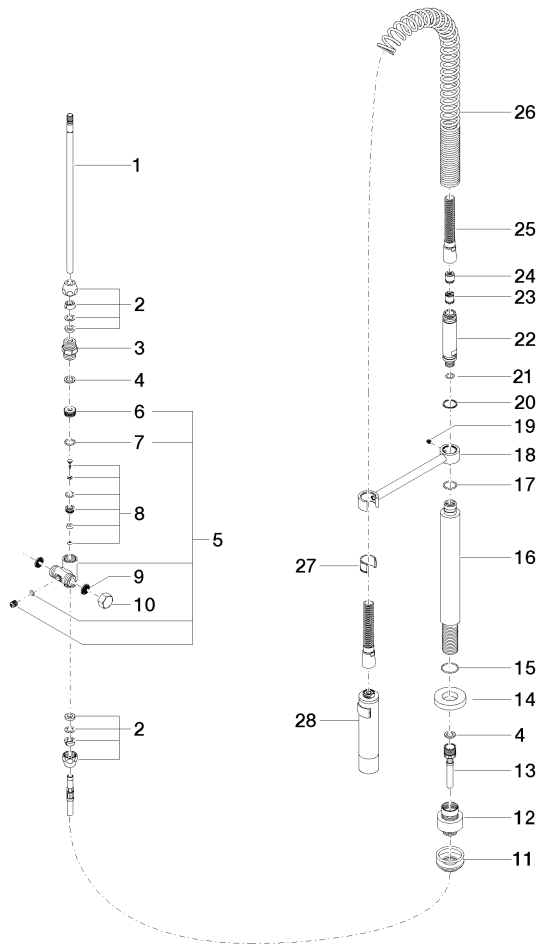

27 789 970

Ersatzteilstückliste

Nr.	Artikelnummer	Benennung	Verbaumenge	Lieferzeit
1	04 24 02 046 01-07	Rohr	1	10
2	90 23 30 040 00-00	Verschraubung	2	10
3	90 24 03 168 00 90	Nippel	1	2
4	90 14 20 002 00 90	Dichtung	2	2
5	90 17 09 046 10 90	Umstellung	1	2
6	09 24 04 112 10 90	Nippel	1	2
7	90 14 10 033 00 90	Dichtung	1	2
8	90 21 10 031 10 90	Umstellung	1	2
9	09 23 01 039 90	Sieb	2	2
10	04 21 02 006 00 92	Kappe	1	2
11	04 23 10 004 03 90	Befestigungssatz	1	2
12	12 780 970 90	Verlängerungsset -	1	60
13	09 30 04 067 90	Schlauch	1	2
14	09 28 10 064-00	Rosette	1	10
15	09 14 10 120 90	Dichtung	1	2
16	09 11 10 066 10-00	Anschluss	1	60
17	09 14 10 031 90	Dichtung	1	2
18	04 17 20 014 00-00	Halter	1	10
19	09 31 11 049 90	Stift	1	2
20	09 14 15 012 90	Ring	1	2
21	09 14 10 003 90	Dichtung	1	2
22	09 30 01 067 10-00	Adapter	1	10
23	90 23 01 141 00 90	Rueckflussverhinderer	1	2
24	09 23 01 046 90	Rueckflussverhinderer	1	2
25	90 30 02 065 00-00	Schlauch	1	10
26	09 16 02 034 90	Feder	1	2
27	90 18 40 035 00 90	Huelse	1	2
28	04 12 11 094 10-00	Brause	1	10